

Krono takpanel



Krono Takpanel er panelbord som gir det et flott tak på kort tid. Enkel montering - not og fjær på alle fire kanter. Stabilt materiale i tidløs design. Erstatte tradisjonell panel og tak-ess. Kan også brukes som veggpanel. Krono Takpanel er foliert i fargen NCS S 0502 -Y. Fargegarantien på folien er 10 år.

Takpanel med klikk profil



Dine fordeler ved å velge Krono takpanel

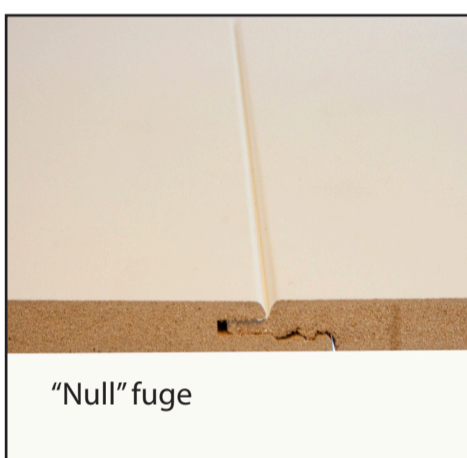

"Null" fuge

Langsgående V-fuge

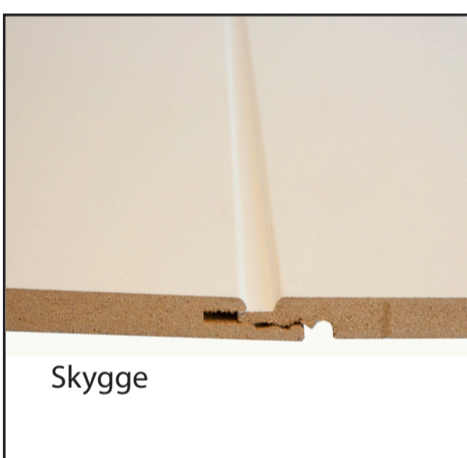

Skygge

Rask montering med det unike klikksystemet

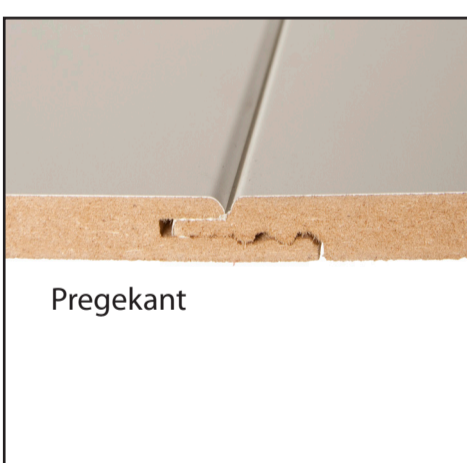

Pregekant

Pen pregekant



Egenskaper:



Tekniske spesifikasjoner:

Tykkelse:	10 mm
Bredde:	154 mm
Lengde:	2400 mm
Per pakke:	2,9568 m ²
Per pall:	118,272 m ²
Vekt per pakke:	17 kg
Vekt per pall:	730 kg

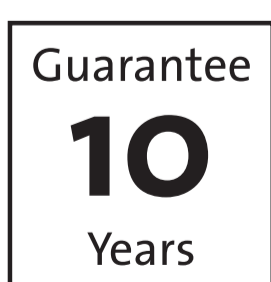

Innhold	Bruttomål	Brutto per pakke	Nettomål	Netto per pakke
Skygge	10x154x2000 mm	2,9568 m ²	134,2x1991 mm	2,57 m ²
Null fuge	10x154x2000 mm	2,9568 m ²	126,8x1991 mm	2,42 m ²

Viktig: Oppbevar panelene i uåpnede pakker i minst 48 timer (min 18 °C) før du begynner å montere dem.

Krono takpanel

Montering:

VIKTIG! Montør er ansvarlig for å kontrollere produktet for eventuelle synlige feil/mangler og skader før montering, da slike klager blir avvist etter montering.

1

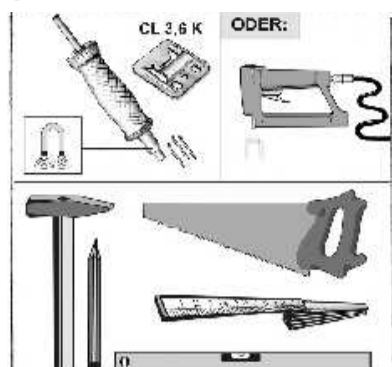

Nødvendig verktøy ved montering av Krono takpanel. All fukttilførende arbeid (støping, muring etc), må være avsluttet i god tid før Krono Takpanel monteres

2

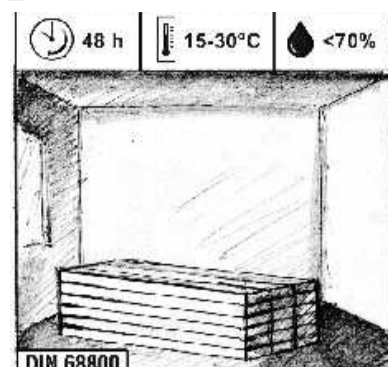

Akklimatiser panelen i emballasjen før legging og oppbevar i rommet hvor det skal legges i 48 timer ved 15-30 °C og 40-70 % relativ luftfuktighet.

3

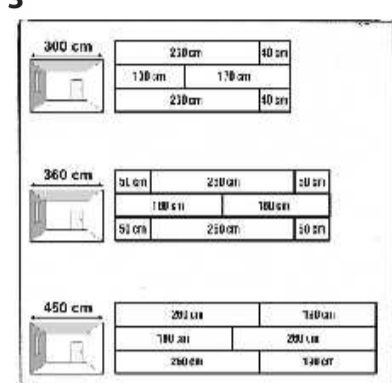

Forbered en plan for legging > optimér skjærester

4

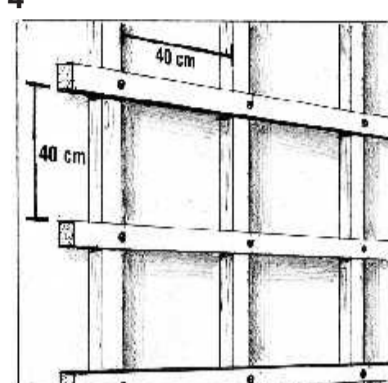

Montér stenderverk. Takpanelen monteres på lekter langsgående av bjelkelaget.

5

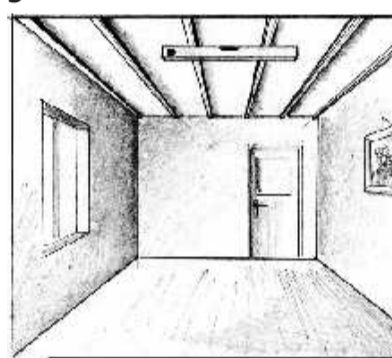

Monteringen skal alltid gjøres på et jevnt og fast underlag.

6

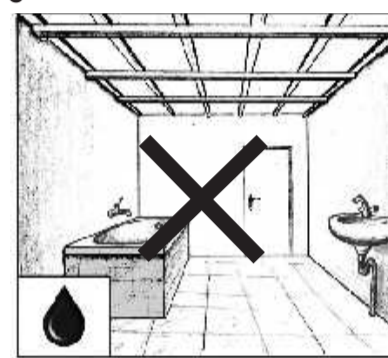

Bør ikke benyttes i våtrom.

7

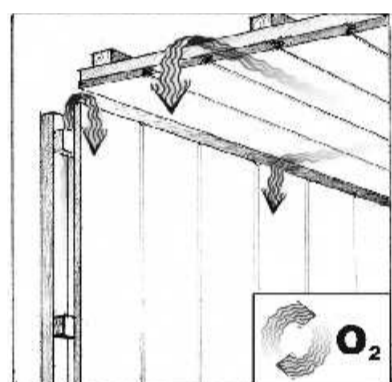

Sørg for bakventilasjon!

8

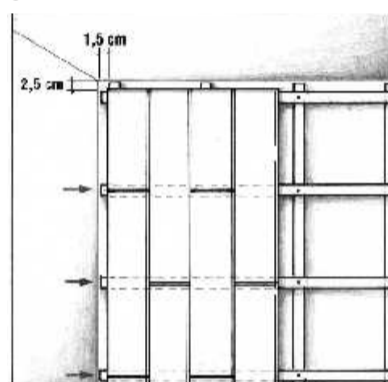

Tverrledd må ha stenderverk bak.

9

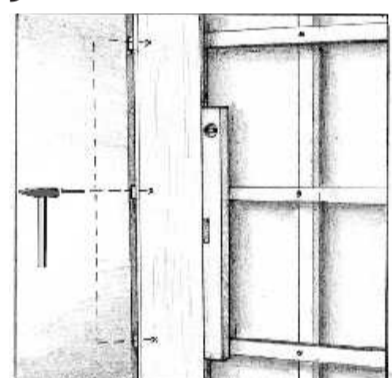

Begynn i et av hjørnene med fjær mot vegg. Bruk vater.

10

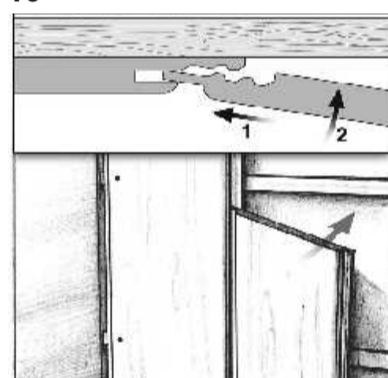

Tilpass ytterligere paneler. Påse at det er helt sammen i not og fjær, og endeskjøter.

11

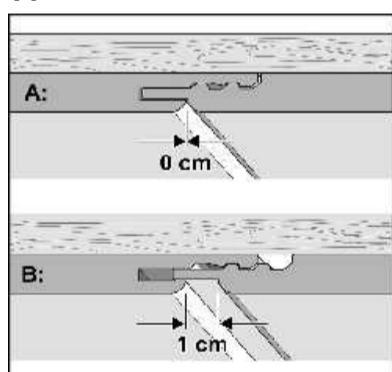

Velg mellom null-fuge (A) eller skygge (B) ved montering av takpanelen.

12



Festes med spiker, skruer eller kramper. Firkant-spiker, varmforzinket 1.7/35.

13

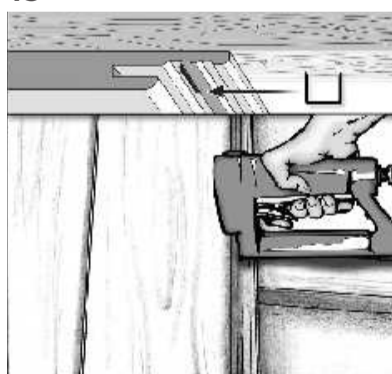

Skruer: 35 4,2 x 35. Kramper CS 500 eller CS 14B/76

14

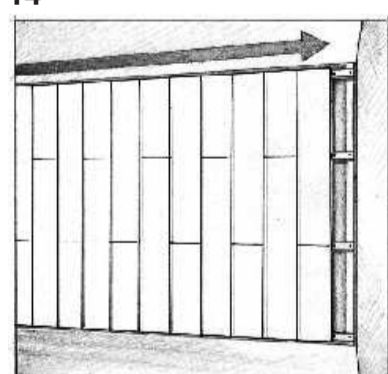

Husk en ekspansjonsfuge på 8-15 mm mot vegg.

15

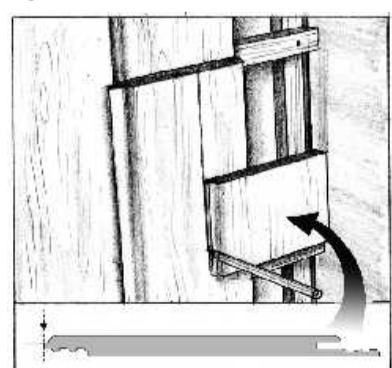

Mål opp siste takbord...

16

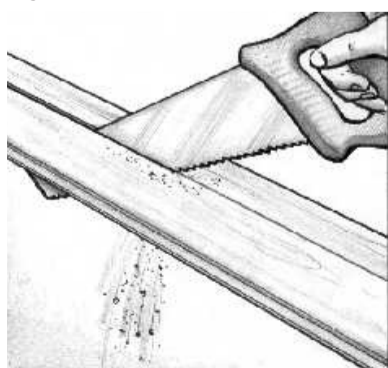

...og skjær til passende størrelse.

17

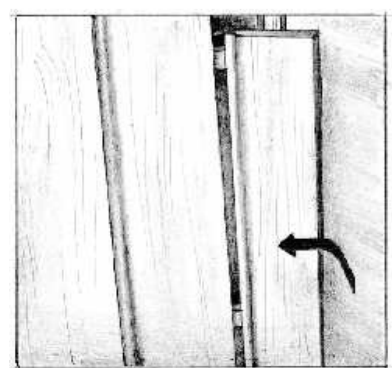

Press takbordene godt sammen.

18

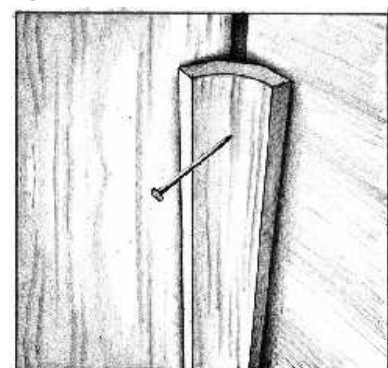

Montér list.